

Article Info

Received: 07 Oct 2018 | Revised Submission: 28 Oct 2018 | Accepted: 02 Nov 2018 | Available Online: 15 Dec 2018

Modelling and Optimization of Process Parameters affecting machining involved in Electric Discharge Machining by GA-ANN

*Shadab Ahmad**, *Praveen***, *Prateek****, *Prateek Kalyani*****, *Ranganath M S******, *R S Mishra****** and *Md Jamil Akhtar******

ABSTRACT

Electric Discharge Machining process is one of the earliest and most extensively used unconventional machining process. It is a non-contact machining process that uses a series of electric discharges to remove material from an electrically conductive workpieces. The EDM process parameter are pulse on time, duty factor, peak current, peak voltage, flushing pressure. This study is aimed to do a comprehensive study of the EDM, develop a model that can predict the machining characteristic and then optimize the output parameters. Artificial Neural Network processes the information by transferring the data between its basic building block i.e. Artificial Neuron. Genetic algorithm is a metaheuristic technique used to find the best fit and approximate solutions to optimization and search problems. In this project we proposed a GA-ANN hybrid model. Also comparison is studied the experimental values and ANN predicted values. GA-ANN model concludes that the error calculated in experimental values V/S ANN-GA predicted values is very less compared to experimental values V/S ANN predicted values

Keywords: *Electric Discharge Machine; Optimization; Artificial Neural Networks.*

1.0 Introduction

Electrical Discharge Machining (EDM) is one of the earliest and most extensively used machining process. It is a thermal metal erosion process that uses series of electrical discharges to remove material from an electrically conductive workpiece. Unlike the traditional machining processes such as drilling, milling, turning etc. there is no contact between the workpiece and the tool in the EDM process, i.e. instead of using mechanical forces to fracture the material, a series of electrical pulses is used to erode it. The electrical discharges occurring due to the

pulsating voltage applied across the electrodes results in melting of the workpiece which is then flushed by the surrounding dielectric.

During the EDM process a gap of about 40 μm is maintained between the electrodes using a servo mechanism and a pulsating direct current supply is connected across them. As shown in Fig. 1 which describes the general schematic diagram of Electro Discharge Machining, the electrodes are immersed in a dielectric material such as hydrocarbon oil, deionized water, cutting oils etc. When a gap voltage ($V_g \approx 200\text{V}$) is applied across the electrodes, due to the resulting high electric field between the

**Corresponding Author: Department of Mechanical, Production & Industrial and Automobiles Engineering, Delhi Technological University, Delhi, India (E-mail: sheo2008@gmail.com)*

***Department of Mechanical, Production & Industrial and Automobiles Engineering, Delhi Technological University, Delhi, India*

****Department of Mechanical, Production & Industrial and Automobiles Engineering, Delhi Technological University, Delhi, India*

*****Department of Mechanical, Production & Industrial and Automobiles Engineering, Delhi Technological University, Delhi, India*

******Department of Mechanical, Production & Industrial and Automobiles Engineering, Delhi Technological University, Delhi, India*

******Department of Mechanical, Production & Industrial and Automobiles Engineering, Delhi Technological University, Delhi, India*

******Department of Mechanical, Production & Industrial and Automobiles Engineering, Delhi Technological University, Delhi, India*

electrodes, breakdown of the in between dielectric material takes place and a plasma channel is developed after a certain delay time. Once the plasma channel is set up, discharge current starts flowing in the circuit, the voltage across the electrodes falls to a lower value ($V_d \approx 25V$), during this pulse on time (ton), the temperature of the plasma reaches as high as 40,000K and a melt pool of the molten electrodes is produced [1]. Due to such a high temperature vaporization of the electrodes as well as the dielectric takes place, the gases formed confines the plasma channel in a bubble and the pressure within this gas bubble can be as high as 14 bars. This high pressure results in superheating of the molten metal. When the applied voltage turns off during the pulse off time (t_{off}), the gas bubble implodes violently flushing the molten metal out of the melt pool, and a crater about 100 μm wide is left out. The voltage and pulse waveforms measured at the gap in a typical EDM operation is shown in Fig. 2. This process is repeated many times throughout the whole workpiece surface during the machining process, to remove the desired amount of material from the workpiece. A more detailed description of the material erosion mechanism is given in section 2.1.2.

2.0 Types of Edm Processes

The most common types of EDM are:-

- 1 Die Sinking EDM:- The die-sinker EDM uses a shaped tool electrode and workpiece which are immersed in a dielectric fluid, when the voltage is applied across the electrodes, erosion of

Fig 1: Schematic Diagram of an EDM Machine [2]

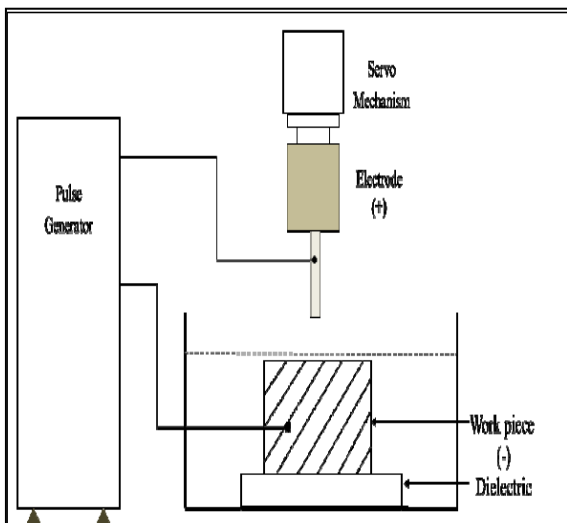
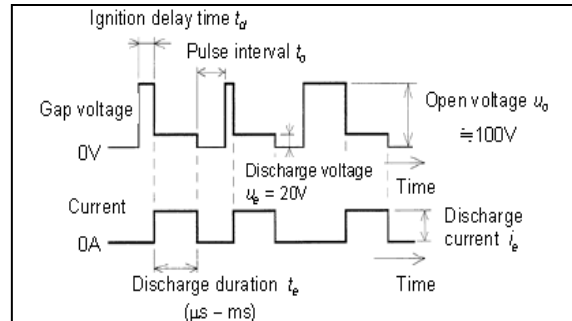

Fig 2: Voltage and Pulse Waveforms of an EDM Machine [3] workpiece takes place and the tool the tool shape is replicated on it.



- 2 Wire EDM (WEDM):- The wire EDM uses a thin continuously travelling metallic wire usually made of copper, brass or tungsten and having a diameter of around 0.05-0.3mm. This wire is always kept in tension using a mechanical tensioning device and is fed through the workpiece which is submerged in a dielectric fluid. The metal ahead of the wire gets eroded, and the wire is controlled numerically to produce desired shapes and cavities without the requirement of pre-shaped electrodes. De-ionized water is mostly used as the dielectric fluid in case of WEDM, due to its low viscosity and fast cooling rate [4].

Using wire EDM hard conductive materials can be machined easily to produce complex and precision components. The WEDM can produce surface finish as fine as 0.04-0.25 μRa , and the residual stresses in the EDMed surface is very low. Typical cutting rates of WEDM are 300 mm^2/min for a 50 mm thick D2 tool steel and 750 mm^2/min for a 150 mm thick aluminium plate. Fig. 3 shows the schematic diagram of the wire EDM process.

Fig 3: Schematic Diagram of Wire EDM [6]

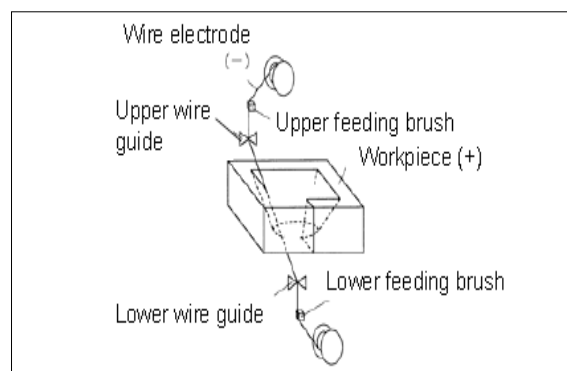
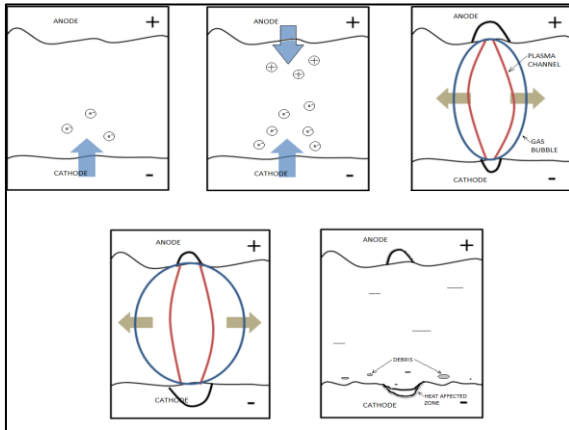

Fig 4: Diagrammatic Representation of EDM Metal Erosion Mechanism



Pandey and Jilani [10-12] presented a thermo-mathematical model describing the EDM process. For a disc shaped heat source and a semi-infinite workpiece, the cylindrical heat conduction equation was solved numerically with appropriate initial and boundary conditions, taking into account the effect of plasma channel widening [11]. Consideration of the plasma channel expansion improves the consistency between the theoretically predicted values and the experimental outcomes. Thickness of the heat affected zones were also predicted with reasonable accuracy [10]. The effect of non-rectangular pulses on the material removal and the relative electrode wear was studied and the optimum current pulse form in terms of the relative electrode wear was found out [12]. F S Van Dijck et al. [13] calculated the exact solution of a two dimensional transient heat conduction equation for a semi-infinite body subjected to a time dependent uniform heat flux. Plasma channel widening is taken into account to improve the accuracy of the model. Pandit and Rajurkar [14] developed a hybrid thermal model of transient temperature distribution in the EDM process using Data Dependent Systems (DDS) and the heat conduction equation. A complex and stochastic process such as EDM can be modeled using DDS directly from the experimental data, and any other knowledge about the system is not required in this approach. A first order DDS model of the machined surface generated after EDM process is combined with the heat conduction equation using some realistic assumptions. The model used a circular heat source and semi infinite workpiece assumption and the results matched well with the experimental

results. A. Erden et al. [15] examined 8 different Mathematical models of EDM process and compared their predictions with experimental outcomes. He concluded that the point heat source model used by Zingerman and Carslaw gave satisfactory result with low computation time but the predicted crater shape was in accurate while the model developed by Pandey and Jilani [10], gave the best results among 2D models in terms of crater volume and computing time.

An extensive research on the EDM process was carried out at the Texas A&M University, and a series of three papers was released afterwards. The first paper by DiBitonto et al. [1] proposed a simple cathode erosion model of the EDM process. Several simplifying assumptions were used, that apply to a cathode erosion model with reasonable accuracy, such as a point heat source model; a constant fraction of the total power is lost to the cathode independent of current and pulse time; average thermo physical properties of the cathode material apply to the range of solid to liquid etc. The model predicted the pulse time with an average of 16% error for steel, when the model was tuned to a single experimental point of 12.8A current. They also presented a dimensionless universal model of the EDM process, that included two dimensionless parameters g (optimum pulse time factor) and j (erodibility).

At last the Compton's energy balance for gas discharges was modified for EDM process. In the second paper Mukund R. Patel et al. [16] proposed an anode erosion model, in which all the simplifying assumptions similar to the above paper were used. The plasma radius expansion at the Anode was also taken into consideration and a Gaussian heat flux distribution was used. The model is able to show the rapid melting of the anode material and its successive resolidification at longer pulse times and predict the erosion rate curves qualitatively correct. Also the plasma flushing efficiency predicted by this model is within experimental uncertainty compared to the experimental data of the AGIE EDM technologies. The third paper by Phillip T. Eubank et al. [17] presents a variable mass cylindrical plasma model for the sparks created in a liquid dielectric by the electrical discharge during EDM process. The theoretical model is formulated by solving three differential equations i.e. a fluid mechanics equation, an energy balance equation, and a radiation balance equation combined with a plasma equation of state.

Numerical solutions of these equations are developed yielding temperature, plasma radius, mass and pressure as a function of pulse times for fixed current, electrode gap and the power fraction remaining in the plasma. These three papers although based on comprehensive research used oversimplifying assumptions and are unable to give satisfactory results for small discharge energies.

The material removal rate during an EDM process is affected by various process parameters, out of which the pulse waveform is among the most influential factor. A. Erden et al. [18] studied the effect of different energy pulse forms on the MRR and relative electrode wear. He concluded that the commonly used rectangular pulses are not the optimum pulse forms and more general pulse shapes offer better MRR and lower REW. Out of these pulses he advocated for trapezoidal, because they can be achieved cheaply and the trapezoidal pulses with negative slopes gives high MRR in comparison to the rectangular pulses although REW is also high while positive slopes give less MRR as well as less REW.

Singh and Ghosh [8] proposed that the electrostatic forces acting on the metal surface are responsible for metal removal in case of short pulses (discharge duration $< 5\mu\text{s}$), while melting is the dominant factor for metal removal in case of long discharge durations (discharge duration $> 100\mu\text{s}$). They estimated the electrostatic forces acting on the surface of the metal and the stress distribution within the metal due to the electrostatic forces. The model explains that crater depth is independent of the discharge duration (t_d), for small values of t_d and increases for medium discharge duration.

3.0 Numerical/Computational Models

Equations governing the EDM process are hard to model and solve using analytical techniques, hence a large number of researchers have heeled toward the use of numerical methods. Numerous papers are present devoted to the numerical modeling of the EDM process [3,19-25]. All the different factors that influence the EDM performance are tried to be incorporated in these computational models, to improve the model accuracy.

P. Shankar et al. [25] used finite element method to solve equations governing the temperature and current simultaneously. In the model discharge process and heat transfer within the electrodes and dielectric were accounted. The variations in the

material properties with change in temperature was used in the model. The electrode region was divided into a 2D mesh using an automatic mesh generation program and the Glaerkin's method was used to solve the partial differential equations. The spark profile, energy distribution between the electrodes, MRR and REW was calculated and compared with the experimental results. Discrepancies were found between the experimental and theoretically predicted MRR and REW values, because of the assumption made while formulating the model.

Marafona and Chousal [24] proposed a Joule heating based model, in which heat dissipated by the cylindrical heat source is governed by Joule heating effect. ABAQUS software was used to develop a FEM model, and the results were compared with Ref. [1]. The two results followed the same pattern but appreciable discrepancy was present between the two models. A user subroutine was used by Y.B. Guo et al. [22] to develop Gaussian heat flux distribution in a multiscale diesinker EDM model of ASP2023 tool steel.

The finite element computational packages (such as ANSYS, ABAQUS, HYPERMESH etc.) provide an interactive tool to researchers using which they can model complex processes, which will otherwise be very hard or even impossible to model using analytical methods. H. K. Kansal et al. [26] used the finite element method to develop a model of the powder mixed EDM (PWEDM) process. Critical features such as change in material properties with temperature, heat distribution between the electrodes, size and shape of heat source, pulse on/off time, phase change of material, material ejection efficiency were considered in the model, and the effect of different process parameters on the temperature distribution was analyzed. Their model predicted MRR values with good accuracy, compared to the experimental results. They also concluded that the PMEDM model produced craters which are smaller and shallow craters. Borja Izquierdo et al. [27] developed a finite element model addressing the successive discharges that takes place in a real EDM process in spite of the single discharge model used by most of the researchers.

4.0 ANN Models

Artificial neural networks are intelligent tools which can be used to model complex nonlinear relationships between variables by mimicking the

working process a nervous system [31]. An artificial neural network consists of a network of artificial neurons that can learn the complicated relationship between the input variable such as various process parameters like discharge voltage, current, machining time, pulse on time etc. and the corresponding output variable i.e. surface roughness, MRR etc. A set of experiments is designed and fed to appropriate ANN model, which models the interrelation between the input and output variables and then can be used to predict the outcome of an out of set machining parameter set. The data set provided to the ANN model is divided into two sets, namely, training and testing data sets. The training data set is used to train the neural network while testing data set is used to check the accuracy of the model's prediction. A number of researchers [32-41] used ANN to create a model of the EDM process, to predict the effect of various process parameters [34,37,39] and for the process optimization [32,35,38,41].

Assarzadeh and Ghoreishi [35] used a 3-6-4-2 neural network trained to model the EDM process of BD3 steel material machined using copper electrode. Here 3-6-4-2 denotes that the neural network had 4 layers, one input layer with 3 neurons, two hidden layers with 6 and 4 neurons respectively and one output layer with 2 neurons. The machining was carried out 96 times using different input parameters out of which 82 sets were used for training and the rest for testing. The trained network predicted the MRR and Ra values for the testing data set with 5.31% and 4.89% mean error.

The selection of optimum network topology is a rigorous process and there is no general method available for its prediction, hence usually the trial and error approach is used for its selection. Panda and Bhoi [38] provided a detailed comparison of the performance of ANN models having different number of hidden layers and the number of neurons in each layer, that was used for the prediction of metal removal rate corresponding to input parameters. The network was trained using Levenberg Marquardt Backpropagation algorithm. The 3-7-1 network was found to give the most accurate results. Tsai and Wang [33] compared six different neural networks and a neuro-fuzzy network in terms of the error in their predicted outputs. The neuro-fuzzy system was found optimal for the given experimental data set.

A genetic algorithm is a robust heuristic global optimization tool that can be used to calculate global

maxima in a multimodal search space. GA's are coupled with neural networks in two different ways.

Genetic Algorithms are used to optimize the EDM process by selecting the machining input parameters corresponding to the optimum output characteristic, such as high MRR, or low Ra etc. using a trained neural network[33,38,43,44].

A hybrid approach has been adapted by some researchers in which GA is used to optimize the network weights in order to improve the network predictions [33,37].

4.1 Experimental data

The experimental data presented in table 1 has been used to develop a Hybrid GA-ANN based model that can predict the machining characteristic using the set of machining inputs and its output. The experiments were performed on ELECTRONICA-ELECTRAPLUS PS 50ZNC (die sinking type) EDM machine in the LML company in Kanpur (U.P). This data has been used with due permission from the original experimenter.

Set of experiment were designed using a L27 orthogonal array with 5 input parameters and one output parameter. The selected input parameters are Gap Voltage, Pulse Current, Pulse On Time, Pulse Off time, and Flushing pressure, and the corresponding measure output is the Material Removal Rate (MRR). This set of experiments is used to develop a neural network model which can accurately predict interpolate machining output for off sample data points, i.e. set of machining inputs which area are not present in the experimental set.

Table 1: Experimental Set of Data

Exp. No	Gap voltage (V)	Pulse current (A)	Pulse off time (µs)	Pulse on time (µs)	Flushing pressure (kg/cm ²)	MRR (gm/min)
1	50	9	15	90	0.25	0.092805
2	50	9	15	90	0.50	0.095663
3	50	9	15	90	0.75	0.099430
4	50	12	45	120	0.25	0.138074
5	50	12	45	120	0.50	0.141079
6	50	12	45	120	0.75	0.137190
7	50	15	90	150	0.25	0.158560
8	50	15	90	150	0.50	0.145560

9	50	15	90	150	0.75	0.160241
10	60	9	45	150	0.25	0.065670
11	60	9	45	150	0.50	0.065600
12	60	9	45	150	0.75	0.065480
13	60	12	90	90	0.25	0.065408
14	60	12	90	90	0.50	0.144221
15	60	12	90	90	0.75	0.150787
16	60	15	15	120	0.25	0.154021
17	60	15	15	120	0.50	0.175421
18	60	15	15	120	0.75	0.176577
19	70	9	90	120	0.25	0.074460
20	70	9	90	120	0.50	0.069428
21	70	9	90	120	0.75	0.071915
22	70	12	15	150	0.25	0.094715
23	70	12	15	150	0.50	0.096211
24	70	12	15	150	0.75	0.098076
25	70	15	45	90	0.25	0.180139
26	70	15	45	90	0.50	0.171739
27	70	15	45	90	0.50	0.180506

ensured then using the validation points, and then the model is used to predict the outcome at the set of input parameters corresponding to the testing data points, which were not fed to the neural network during the training process.

The corresponding regression plot is shown in figure 5. The comparison between the experimental outcomes and the network predicted values is shown in figure 6.

The total correlation coefficient is found to be equal to 0.9987 for the ANN model.

Table-2: Parameter Values of Feed-Forward Backpropagation Neural Network

Topology of the Neural Network	Feed-forward
Learning Algorithm	Scaled Conjugate Gradient
Number of hidden layers	1
Number of neurons in hidden layer	10
Iterations	2000
Max-validation checks	20
Performance function	Mean Square Error
Number of weight elements	71
Training Divide Function	Random
Training ratio	0.7
Validation ratio	0.15
Testing ratio	0.15

Fig 5: Regression curve of ANN model

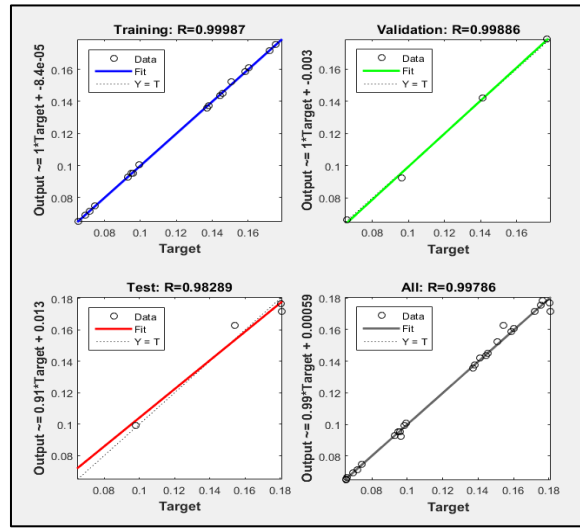

4.2 GA-ANN model

A hybrid GA-ANN model was then developed afterwards using the same parameter settings selected for the ANN model as shown in Table 2. Table 3 shows the various parameters selected for the Genetic algorithm program that is used as a training algorithm in this model. The corresponding regression curve is shown in Fig. 16, and the Fig. 17 shows the comparison between the GA-ANN model predicted values and the experimental values.

Total Correlation coefficient of 1 is obtained using the hybrid model. As it can be seen from the figures 7 and 8, significant improvement in the network predictions are obtained on using the hybrid training algorithm. Figure 8 compares the errors between the predicted and the actual values for the two models.

From the figure 9, the maximum error in case of the ANN model that was around 17.52% reduces to 7.5% in case of the GA-ANN model which means is 43% decrease in the maximum error. It shows that the developed GA-ANN model is better than the simple ANN model. Optimum Machining output Prediction :- The developed hybrid GA-ANN model is then used to calculate the optimum machining characteristics and the corresponding set of input parameters. The control of the developed model was passed to a genetic algorithm which generates a population of set of input parameters in the form of chromosomes. The fitness function was selected as the MRR. These chromosomes are then evolved to the optimum MRR value by using the genetic operators.

The result of which is shown in Table 4. The maximum MRR value obtained in the experimental data set is 0.180506 gm/cc, while the optimum value of MRR obtained is 0.2184 gm/cc which is a 21% increase in the material removal rate.

Fig 6: Comparison Between the Ann Predicted and Experimental Outcomes for The Ann Model

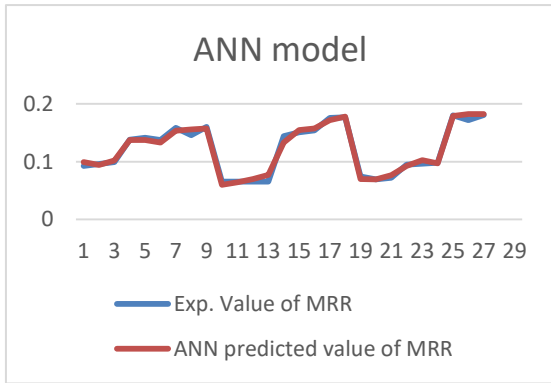

Table-3: Parameter values of the Genetic Algorithm

Population Size	200
Population Type	Double Vector
Selection Function	Stochastic Uniform
Crossover Method	Scattered Crossover
Mutation Method	Gaussian
Mutation Probability	0.01
Stopping Criterion	Tolerance Value
Tolerance Value	10^{-15}

Fig 7: Regression curve of ANN model

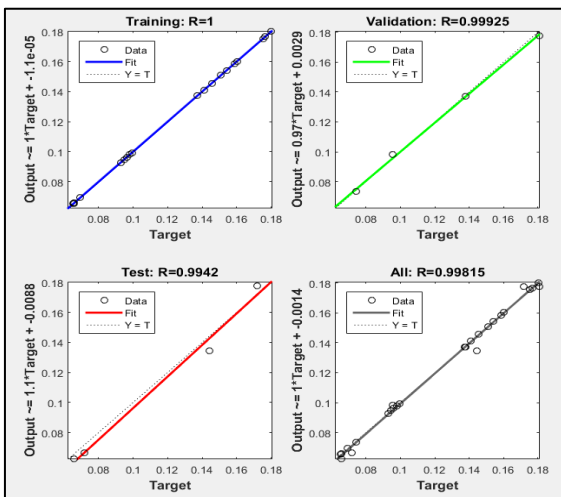

Fig.8: Comparison Between the Ann Predicted and Experimental Outcomes for the Ga-Ann Model

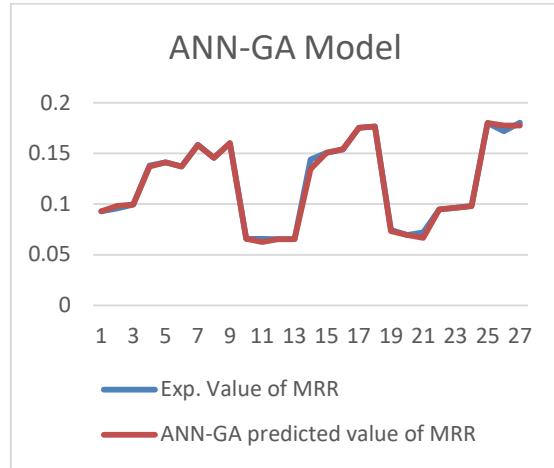

Fig. 9: Error Histogram of the GA-ANN & ANN model

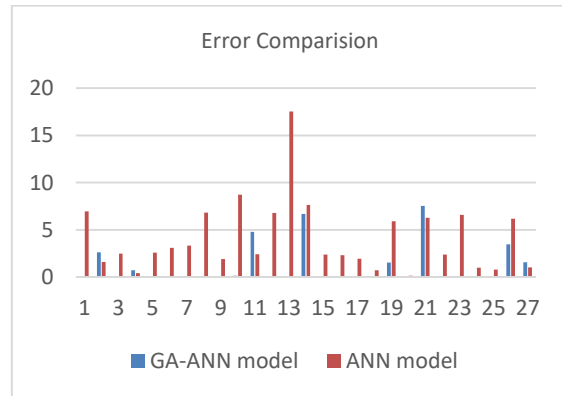

Table-4: Optimum Machining Characteristics.

Machining parameters for achieving Maximum MRR	
Gap Voltage	56.907
Pulse Current	15.00
Pulse off time	44.99
Pulse on time	123.67
Flushing Pressure	0.5069
MRR	0.2184

Conclusions

- A large number of different techniques and methods are used for EDM process modeling, e.g. mathematical models, analytical models, numerical/computational models and AI based models.

- None of these models are perfect and certain disadvantages are present with all these models.
- The mathematical models are found to give satisfactory results only, due to complexity of the process and the large assumptions made to simplify the model.
- Numerical models are very accurate in their predictions and can incorporate most of the factors in the model.
- Analytical models require expensive experimentation, valid in the experimental range and have limited accuracy.
- The AI models are widely by researchers recently and have good generalization capability and quite accurate in their predictions.
- The Hybrid GA-ANN model gave better results in comparison to the simple ANN model, and using it a 47% decrease in the maximum prediction error is noticed.
- A 21% increase in the MRR is got when this model is used to predict the optimum machining characteristic.

References

- [1]. DD DiBitonto, PT Eubank, MR Patel, MA Barrufet. Theoretical Models of the Electrical Discharge Machining Process, IA Simple Cathode Erosion Model. *Journal of Applied Physics*, 66(9), 1989, 4095-4103.
- [2]. A Deshmukh. Modeling of Anode Crater Formation in Micro-Electrical Discharge Machining. MSc. Thesis, University of Nebraska-Lincoln, December 2013.
- [3]. M Kunieda, B Lauwers, KP Rajurkar, BM Schumacher. Advancing EDM Through Fundamental Insight into the Process. *CIRP Annals – Manufacturing Technology*, 54(2), 2005, 64-87.
- [4]. KH Ho, ST Newman, SRahimifard, RD Allen. State of the art in Wire Electrical Discharge Machining (WEDM). *International Journal of Machine Tools & Manufacture*, 44(12-13), 2004, 1247-1259.
- [5]. MP Jahan, ABMAli Asad, M Rahman, YS Wong, T Masaki. μ -Electro Discharge Machining (EDM). *Micro-Manufacturing*, John Wiley & Sons, Inc. DOI: 10.1002/978111801570.ch10.
- [6]. BE Stucker, WLBradley, S Norasettekul, PT Eubank. The production of electrical discharge machining electrodes using SLS: Preliminary results. *Solid Freeform Fabr Symp*, 1996, 278–286.
- [7]. KH Ho, ST Newman. State of the art Electrical Discharge Machining (EDM). *International Journal of Machine Tools & Manufacture*, 43(13), 2003, 1287-1300.
- [8]. A Singh, A Ghosh. A Thermo-Electric Model of Material Removal during Electric Discharge Machining. *International Journal of Machine Tools & Manufacture*, 39(4), 1999, 669-680.
- [9]. K Ojha, RK Garg, KK Singh. MRR Improvement in Sinking Electrical Discharge Machining: A Review. *Journal of Minerals and Materials Characterization & Engineering*, 9(8), 2010, 709-739.
- [10]. PC Pandey ST Jilani. Plasma Channel Growth and the Resolidified Layer in EDM. *Precision Engineering*, 8(2), 1986, 104-110.
- [11]. ST Jilani, PC Pandey. Analysis and Modeling of EDM Parameters. *Precision Engineering*, 4(4), 1982, 215-221.
- [12]. ST Jilani, PC Pandey. An Analysis of Surface Erosion in Electrical Discharge Machining. *Wear*, 84, 1983,275-284.
- [13]. FS Van Dijck, WL Dutré. Heat Conduction Model for the Calculation of the Volume of Molten Metal in Electric Discharge. *Journal Physics D:Applied Physics*, 7(6), 1973, 899-910.
- [14]. SM Pandit, KP Rajurkar. A Stochastic Approach to Thermal Modeling Applied to Electro-Discharge Machining. *Journal of Heat Transfer*, 105(3), 1983, 555-562.
- [15]. A Erden, F Arinc, M Kögmen. Comparison of Mathematical Models for Electric Discharge Machining. *Journal of Materials Processing and Manufacturing Science*, 4, 1995, 163-175.
- [16]. MR Patel, MA Burrufet, PT Eubank, DD DiBitonto. Theoretical Models of the Electrical Discharge Machining Process. II. The Anode

- Erosion Model. *Journal of Applied Physics*, 66(9), 1989, 4104-4111.
- [17]. PT Eubank, MR Patel, MA Barrufet, B Bozkurt. Theoretical Models of the Electrical Discharge Machining. III. The Variable Mass Cylindrical Plasma Model. *Journal of Applied Physics*, 73(11), 1993, 7900-7909.
- [18]. A Erden, B Kaftanoglu. Thermo-Mathematical Modeling and Optimization of Energy Pulse Forms in Electric Discharge Machining(EDM). *International Journal of Machine Tool Design and Research*, 21(1), 1981, 11-22.
- [19]. C Mascaraque-Ramirez, P Franco. Numerical Modeling of Surface Quality in EDM Processes. *Procedia Engineering*, 132, 2015, 671-678.
- [20]. Y Zhang, Y Liu, Y Shen, Z Li, R Ji, F Wang. A New Method of Investigation the Characteristic of the Heat Flux of EDM Plasma. *Procedia CIRP*, 6, 2013, 450.
- [21]. M Shabgard, R Ahmadi, M Seyedzavvar, SNB Oliaei. Mathematical and Numerical Modelling of the Effect of Input-parameters on the Flushing Efficiency of Plasma Channel in EDM Process. *International Journal of Machine Tools and Manufacture*, 65, 2013, 79-87.
- [22]. YB Guo, A Klink, F Klocke. Multiscale Modeling of Sinking -EDM with Gaussian Heat Flux via User Subroutine, *Procedia CIRP*, 6, 2013, 438-443.
- [23]. NB Salah, F Ghanem, KB Atig. Numerical Study of Thermal Aspects of Electric Discharge Machining Process. *International Journal of Machine Tools and Manufacture*, 46(7-8), 2006, 908-911.
- [24]. J Marafona, JAG Chousal. A Finite Element Model of EDM based on the Joule Effect. *International Journal of Machine Tools and Manufacture*, 46(6), 2006, 595-602.
- [25]. P Shankar, VK Jain, T Sundararajan. Analysis of Spark Profiles during EDM Process. *Machining Science and Technology*, 1(2), 1997, 195-217.
- [26]. HK Kansal, S Singh, P Kumar. Numerical Simulation of powder mixed electric discharge machining (PWEDM) using Finite Element Method. *Mathematical and Computer Modeling*, 47(11-12), 2008, 1217-1237.
- [27]. B Izquierdo, JA Sanchez, N Ortega, S Plaza, I Pombo. Insight into fundamental aspect of the EDM process using Multidischarge numerical solution. *International Journal of Advanced Manufacturing Technology*, 52(1), 2011, 195-206.
- [28]. E Aliakbari, H Baseri. Optimization of machining parameters in rotary EDM process by using Taguchi method. *International Journal of Advanced Manufacturing Technology*, 62(9), 2012, 1041-1053.
- [29]. ML Jeswani. Roughness and Wear Characteristics of Spark Eroded Surfaces. *Wear*, 51, 1978, 227-236.
- [30]. ML Jeswani. Dimensional Analysis of Tool Wear in Electrical Discharge Machining. *Wear*, 55(1), 1979, 153-161.
- [31]. RM Singari, GS Bajwa, Prateek, Praveen, P Kalyani, S Ahmad. Modeling of Surface Roughness of during Conventional Turning using a Hybrid GA-ANN based model. *IOSR Journal of Mechanical and Civil Engineering*, 13(5) Version IV, 2016, 1-8.
- [32]. K Wang, HL Gelgele, Y Wang, Q Yuan, M Fang. A Hybrid Intelligent Method for modelling the EDM process. *International Journal of Machine Tools & Manufacture*, 43(10), 2003,995-999.
- [33]. KM Tsai, PJ Wang. Comparisons of Neural Network Models on Material Removal Rate in Electrical Discharge Machining. *Journal of International Processing Technology*, 117, 2001,111-124.

- [34]. GKM Rao, G Rangajanardhaa, DH Rao, MS Rao. Development of Hybrid Model and Optimization of Surface Roughness in Electric Discharge Machining using Artificial Neural Network and Genetic Algorithm. *Journal of Materials Processing Technology*, 209, 2009, 1512-1520.
- [35]. S Assarzadeh, M Ghoreishi. Neural-network-based Modeling and Optimization of the Electro-Discharge Machining Process. *International Journal of Advance Manufacturing Technology*, 39, 2008, 488-500.
- [36]. KM Tsai, PJ Wang. Prediction on Surface Finish in Electrical Discharge Machining based Upon Neural Network Models. *International Journal of Machine Tools & Manufacture*, 41, 2001, 1385-1403.
- [37]. AP Markopoulos, DE Manolakos, NM Vaxevanidls. Artificial Neural Network Models for the Prediction of Surface Roughness in Electrical Discharge Machining. *Journal of Intelligent Manufacturing*, 19(3), 2008, 283-292.
- [38]. DK Panda, RK Bhoi. Artificial Neural Network Prediction of Material Removal Rate in Electro-Discharge Machining. *Materials and Manufacturing Processes*, 20(4), 2005, 645-672.
- [39]. MAR Khan, MM Rahman, K Kadirgama. Neural Network Modeling and Analysis for Surface Characteristics in Electrical Discharge Machining. *Procedia Engineering*, 90, 2014, 631-636.
- [40]. R Karthikeyan, PRL Narayanan, RS Naagarazan. Mathematical Modeling for Electric Discharge Machining of Aluminium-Silicon Carbide Particulate Composites. *Journal of Material Processing Technology*, 87, 1999, 59-63.
- [41]. KP Somashekhar, N Ramachandran, J Mathew. Optimization of Material Removal Rate in Micro-EDM Using Artificial Neural Network and Genetic Algorithms. *Materials and Manufacturing Processes*, 25(6), 2010, 467-475.
- [42]. U Caydas, A Hascalik, S Akici. An adaptive neuro-fuzzy inference system (ANFIS) model for wire-EDM. *Expert Systems with Applications*, 3(2), 2009, 6135.
- [43]. CC Kao, AJ Shih, SF Miller. Fuzzy Logic Control of Microhole Electrical Discharge Machining. *Journal of Manufacturing Science & Engineering*, 130(6), 2008, 064502.
- [44]. TJ Ross. *Fuzzy Logic with Engg. Applications*, 2nd Ed., John Wiley and Sons Ltd.
- [45]. O Yilmaz, O Eyercioglu, NNZ Gindy. A user friendly fuzzy based system for the selection of electro-discharge machining process parameters. *Journal of Materials Processing Technology*, 172(3), 2006, 363-371.
- [46]. S Singhal, RM Singari, R Batra, S Nanda. Effective utilization of Fuzzy system and Fuzzy logic in manufacturing: A Review. *Proceedings of the 2016 Int. Conf. on Industrial Engg. & Operations Management*, 3, 2016.
- [47]. CL Lin, JL Lin, TC Ko. Optimization of the EDM process based on the Orthogonal Array with Fuzzy Logic and Grey Relational Analysis. *International Journal of Advanced Manufacturing Technology*, 19(4), 2002, 271.
- [48]. CC Kao, AJ Shih, SF Miller. Fuzzy Logic Control of Microhole Electrical Discharge Machining. *Journal of Manufacturing Science & Engineering*, 130(6), 2008, 064502.